

# **S.B. SYSTEM**

**RETARDED FLOATING SYSTEM**

**MOD. 413 R**

## **INTRODUCTION**

*P/N 6101/1 1 -2000*

*English*

**The following instructions serve to prepare the competition catamarans of F1, F2, F3 and F4 already existing and new, of the different boat builders to install of the Retarded Floating System S.B. System Mod. 413 R**

The cells of safety of the boats must have in the superior part placed a floating balloon housing the shoulders of the driver to be able to put the floating balloon and some holes has to be done in the rear part of the decks how in the figures following.

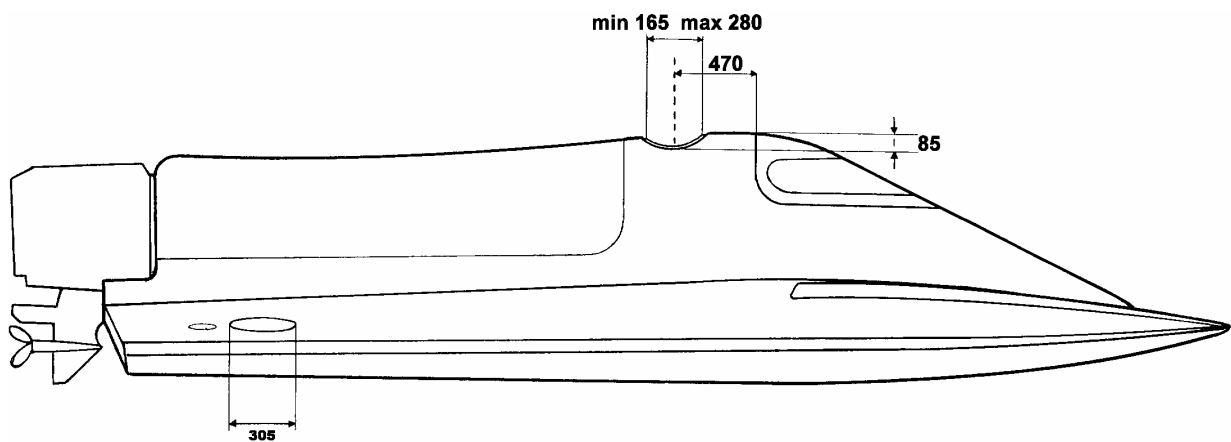

**Side view**

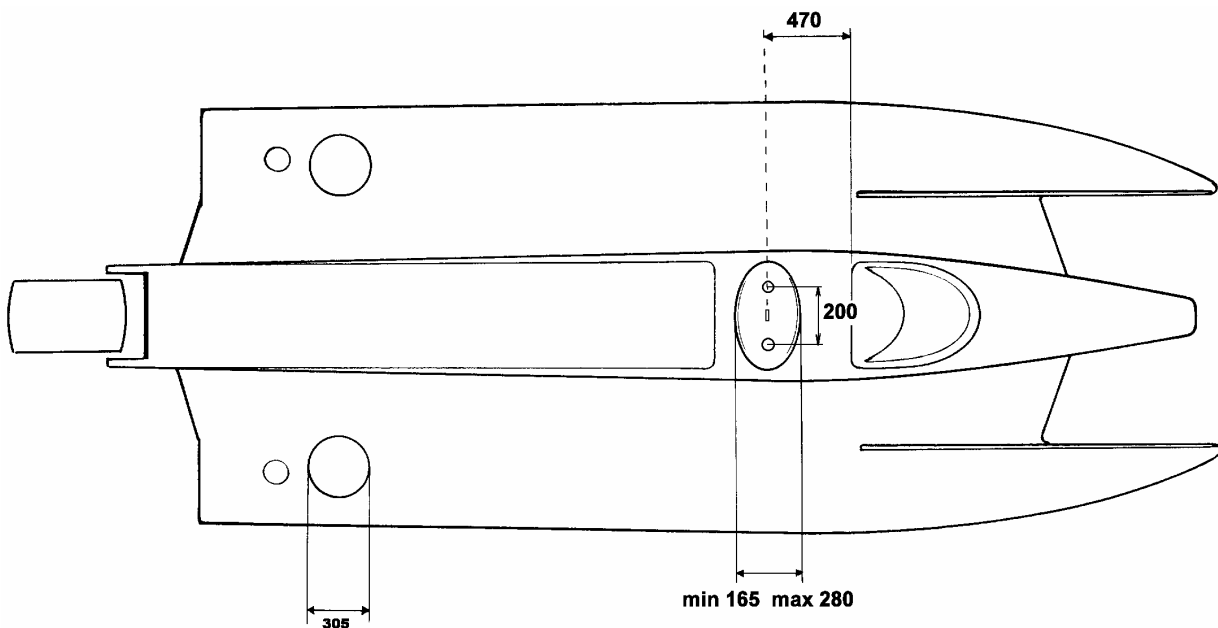

**Top view**

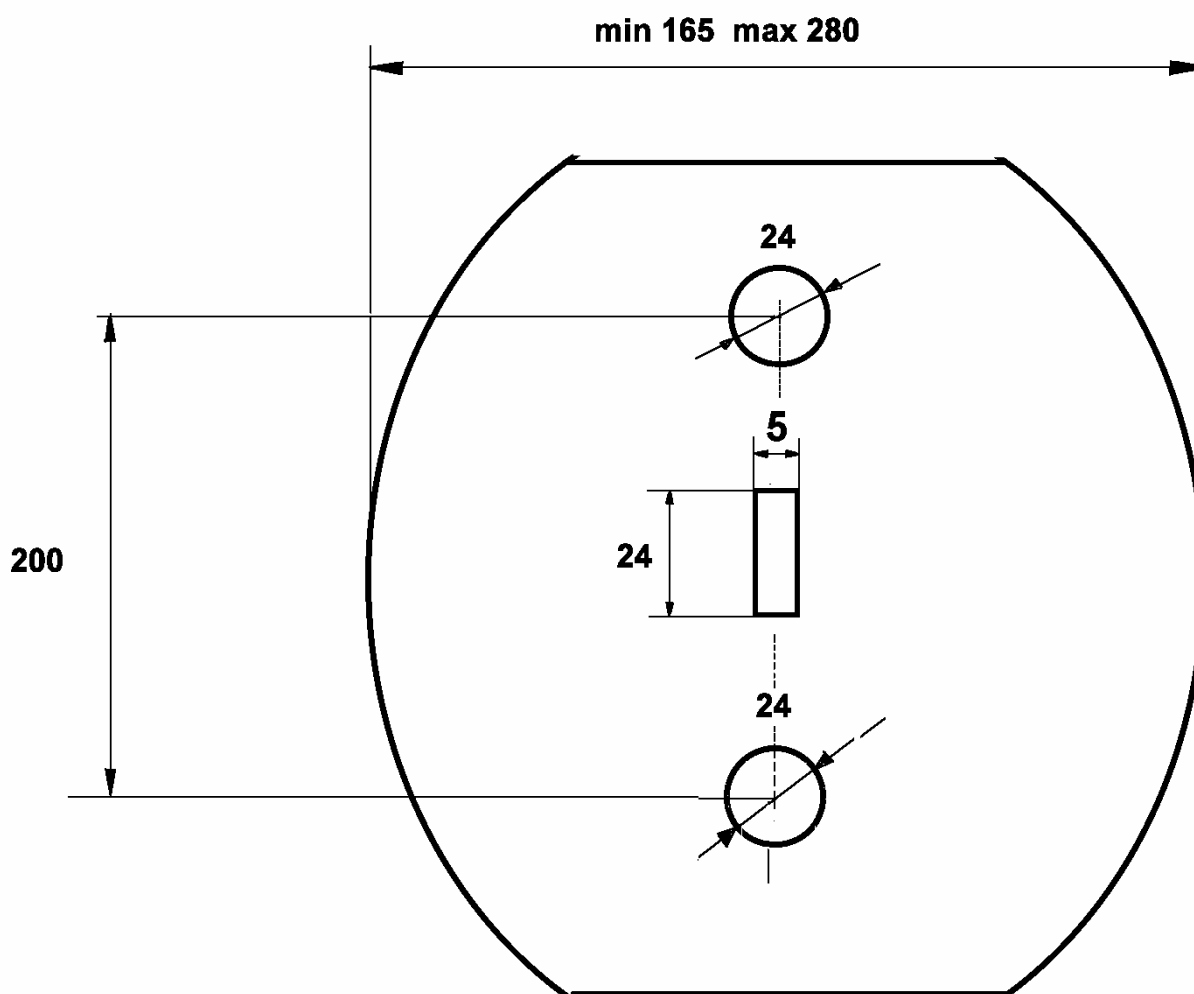

### Dimensions and measures of the floating balloon housing

The measures of the drawings must be respected for the proper inflating of the balloon.

For the boats of F1, F2 and F3 BURGESS and MOLGAARD the S.B. System supplies as additional Kit the floating balloon housing for the balloon to be inserted in the security cell.

For the DAC RACING boats produced as of 1994 the floating balloon housing is already supplemented in the security cell and for the ones produced from 1998 the holes and the corks are present hips in the rear part of the deck.

The following items of the S.B. System: the Nitrogen Cylinder and the valve to High Pressure, after the working in case of reversal of the boat, it has to be replaced to be reproduced, this service is managed by operators for the different Formulae which will be present on the race place with the spare parts necessary to reactivate the system. The names and the addresses are in the following pages

# **S.B. SYSTEM**

## **PARTS CATALOG**

**RETARDED  
FLOATING SYSTEM  
MOD. 413 R**

*P/N 6200/1 2000*

*January 2000*

---



MOLGAARD BOATS  
 FORMULA 1 - FORMULA 2  
**P/N 5006**

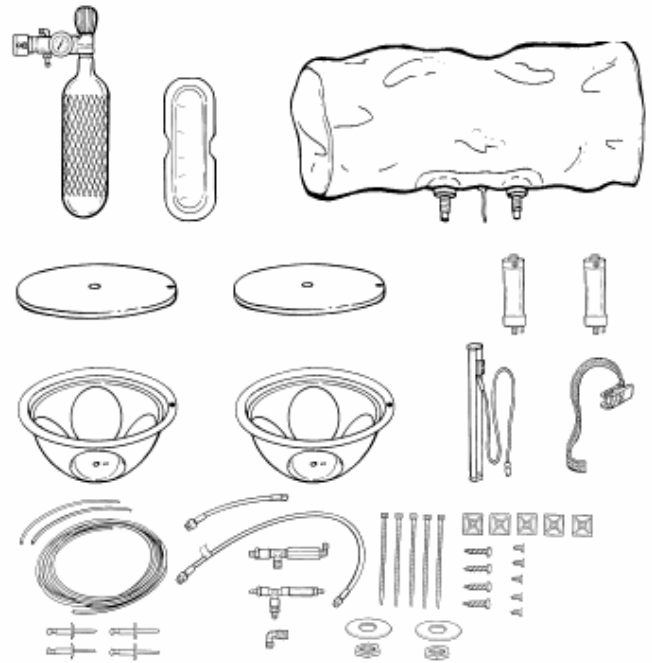

SEEBOLD BOATS  
 FORMULA 1 - FORMULA 2  
**P/N 5007**

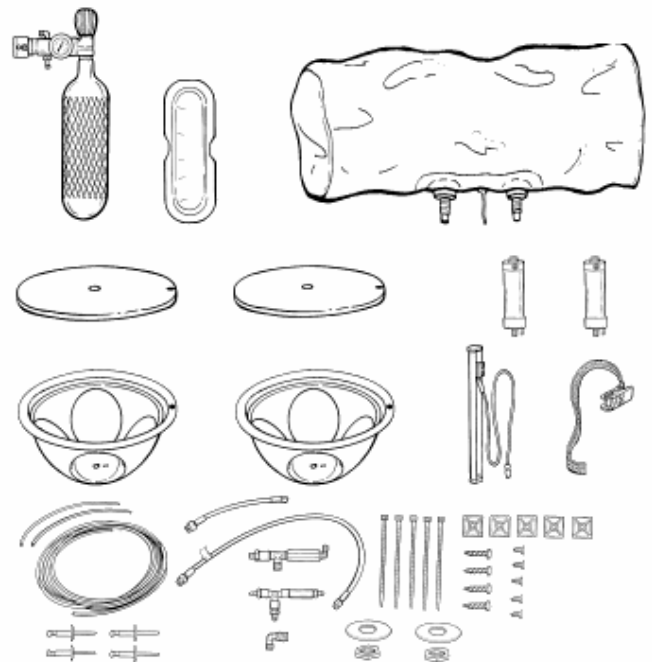

OTHER BOATS  
 FORMULA 1 - FORMULA 2  
 FORMULA 3  
**P/N 5008**

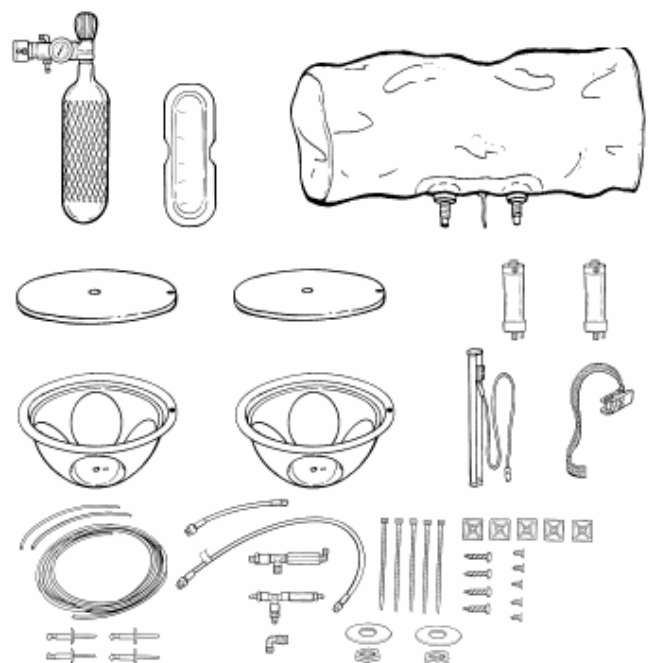

# FLOATING BALLOON HOUSING

---

FLOATING BALLOON  
HOUSING KIT ASSEMBLY for  
BURGESS SAFETY CELL  
**P/N 5805**



FLOATING BALLOON  
HOUSING KIT ASSEMBLY for  
MOLGAARD SAFETY CELL  
**P/N 5806**



# SPARE PARTS

---

NITROGEN BOTTLE WITH  
SWITCH VALVE AND TIMER  
**P/N 5050**



PNEUMATIC PISTON  
Left and Right  
**P/N 5400**

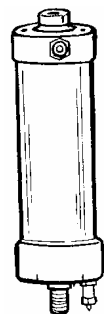

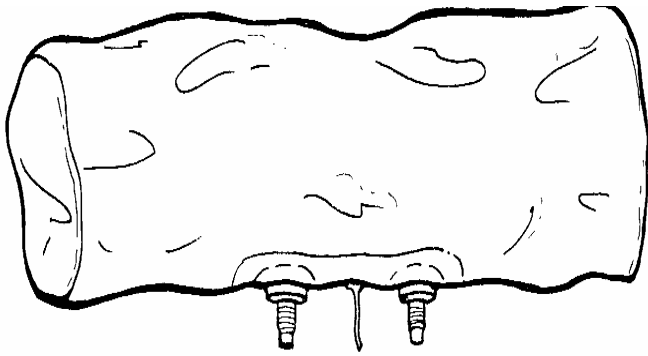

FLOATING BALLOON  
**P/N 5350**

NITROGEN BOTTLE  
**P/N 5100**

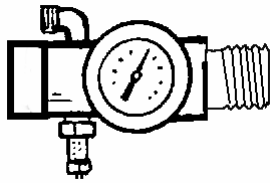
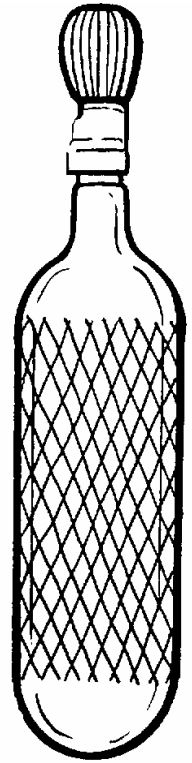

HIGH PRESSURE VALVE  
**P/N 5150**

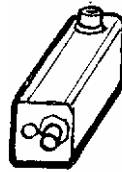

TIMER  
**P/N 5200**

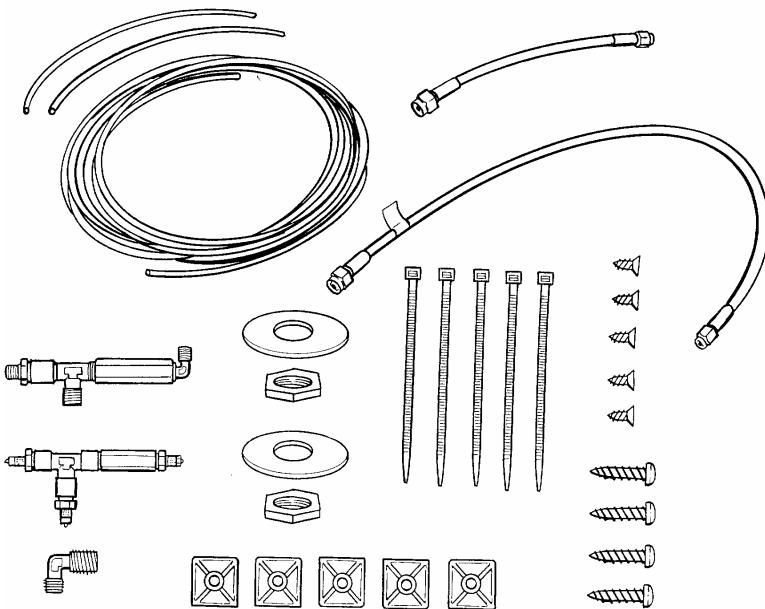

HOSE KIT  
**P/N 5650**

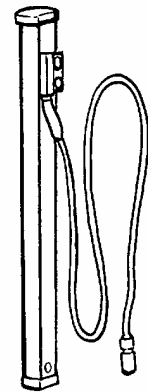

GRAVITATIONAL SWITCH  
**P/N 5300**

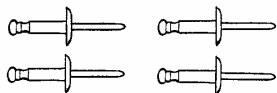

PLASTIC RIVETS  
**P/N 5900**

BOTTLE SUPPORT  
**P/N 5750**

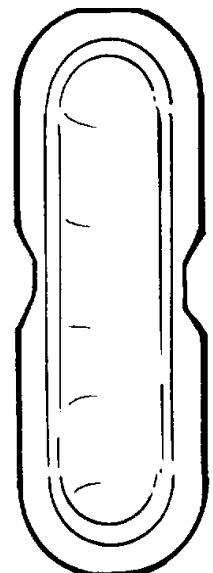

**CORKS and BELLS for BURGESS BOAT**

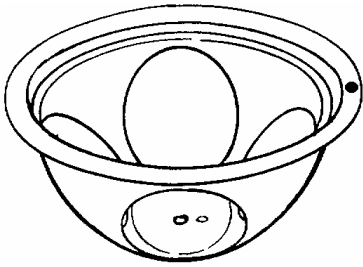

RIGHT BELL for  
BURGESS BOATS  
**P/N 5555**

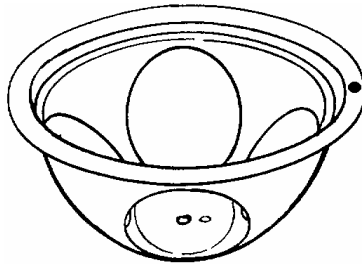

LEFT BELL for  
BURGESS BOATS  
**P/N 5605**

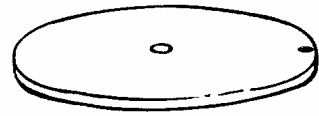

RIGHT CORK for  
BURGESS BOATS  
**P/N 5455**

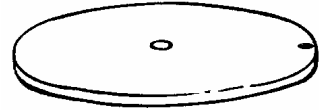

LEFT CORK for  
BURGESS BOATS  
**P/N 5505**

**CORKS and BELLS for DAC RACING BOAT**

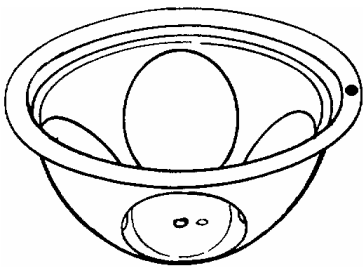

RIGHT BELL for  
DAC RACING BOATS  
**P/N 5550**

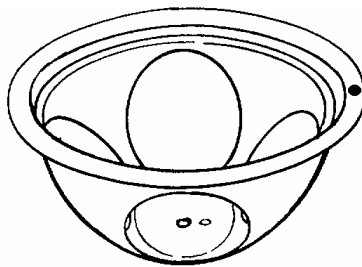

LEFT BELL for  
DAC RACING BOATS  
**P/N 5600**



RIGHT CORK for  
DAC RACING BOATS  
**P/N 5450**

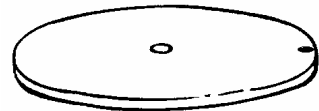

LEFT CORK for  
DAC RACING BOATS  
**P/N 5500**

**CORKS and BELLS for MOLGAARD BOAT**

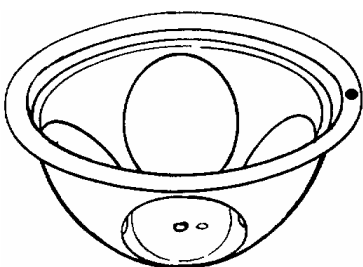

RIGHT BELL for  
MOLGAARD BOATS  
**P/N 5556**

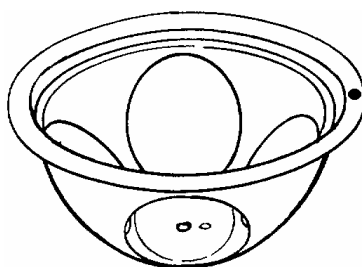

LEFT BELL for  
MOLGAARD BOATS  
**P/N 5606**

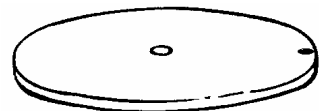

RIGHT CORK for  
MOLGAARD BOATS  
**P/N 5456**

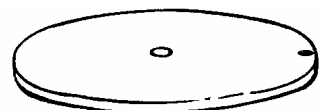

LEFT CORK for  
MOLGAARD BOATS  
**P/N 5506**

**CORKS and BELLS for SEEBOLD BOAT**

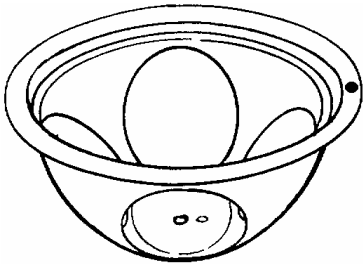

RIGHT BELL for  
SEEBOLD BOATS  
**P/N 5557**

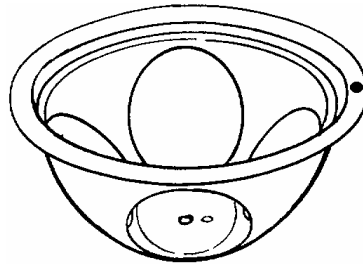

LEFT BELL for  
SEEBOLD BOATS  
**P/N 5607**

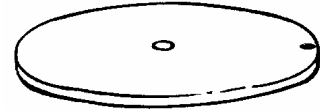

RIGHT CORK for  
SEEBOLD BOATS  
**P/N 5457**

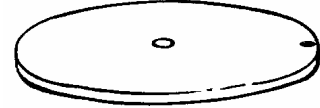

LEFT CORK for  
SEEBOLD BOATS  
**P/N 5507**

**CORKS and BELLS for OTHER BOAT**

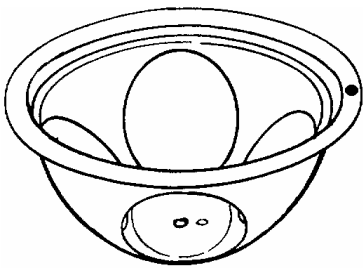

RIGHT BELL for  
OTHER BOATS  
**P/N 5558**

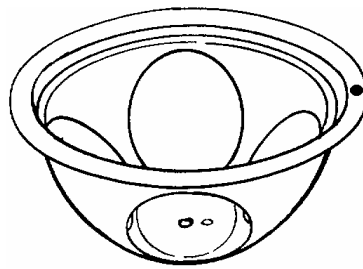

LEFT BELL for  
OTHER BOATS  
**P/N 5608**

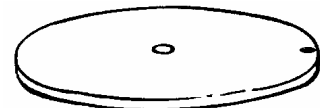

RIGHT CORK for  
OTHER BOATS  
**P/N 5458**



LEFT CORK for  
OTHER BOATS  
**P/N 5508**

# FLOATING BALLOON COVERS

---

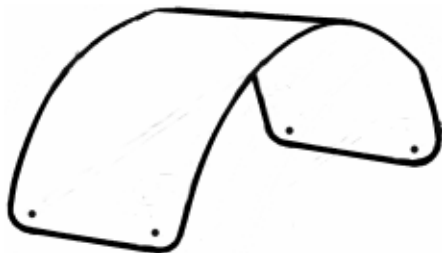

FLOATING BALLOON COVER  
BURGESS BOATS  
**P/N 5855**

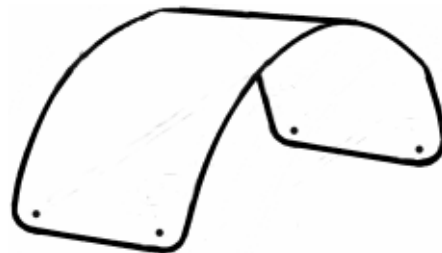

FLOATING BALLOON COVER  
DAC RACING BOATS  
1994 to 1998  
**P/N 5850**



FLOATING BALLOON COVER  
DAC RACING BOATS  
1999 to ----  
**P/N 5851**



FLOATING BALLOON COVER  
MOLGAARD BOATS  
**P/N 5856**

# SYSTEM REPLACEMENT

---

\*SUBSTITUTION OF BOTTLE  
AND HIGH PRESSURE VALVE  
AFTER ONE TIME WORKING  
**P/N 5700**

\* Service available on the RACE PLACE.

# S.B. SYSTEM

RETARDED FLOATING SYSTEM Mod. 413R

## PRICE LIST

Part Number	DESCRIPTON	Page	PRICE
5000	COMPLETE SYSTEM for DAC RACING BOATS 1994 to 1997		USD 2.000
5001	COMPLETE SYSTEM for DAC RACING BOATS 1998 to ----		USD 1.800
5005	COMPLETE SYSTEM for BURGESS BOATS		USD 2.000
5006	COMPLETE SYSTEM for MOLGAARD BOATS		USD 2.000
5007	COMPLETE SYSTEM for SEEBOLD BOATS		USD 2.000
5008	COMPLETE SYSTEM for OTHER BOATS		USD 2.000
5050	BOTTLE WITH SWITCH VALVE AND TIMER		USD 1.100
5100	NITROGEN BOTTLE		USD 100
5150	HIGH PRESSURE VALVE		USD 650
5200	TIMER		USD 400
5300	GRAVITATIONAL SWITCH		USD 100
5350	FLOATING BALLOON		USD 250
5400	PNEUMATIC PISTON (Left and Right)		USD 175
5450	RIGHT CORK for DAC RACING BOATS		USD 60
5455	RIGHT CORK for BURGESS BOATS		USD 60
5456	RIGHT CORK for MOLGAARD BOATS		USD 60
5457	RIGHT CORK for SEEBOLD BOATS		USD 60
5458	RIGHT CORK for OTHER BOATS		USD 60
5500	LEFT CORK DAC RACING BOATS		USD 60
5505	LEFT CORK for BURGESS BOATS		USD 60
5506	LEFT CORK for MOLGAARD BOATS		USD 60
5507	LEFT CORK for SEEBOLD BOATS		USD 60
5508	LEFT CORK for OTHER BOATS		USD 60
5550	RIGHT BELL for DAC RACING BOATS		USD 75
5555	RIGHT BELL for BURGESS BOATS		USD 75
5556	RIGHT BELL for MOLGAARD BOATS		USD 75
5557	RIGHT BELL for SEEBOLD BOATS		USD 75
5558	RIGHT BELL for OTHER BOATS		USD 75
5600	LEFT BELL FOR DAC RACING BOATS		USD 75
5605	LEFT BELL for BURGESS BOATS		USD 75
5606	LEFT BELL for MOLGAARD BOATS		USD 75
5607	LEFT BELL for SEEBOLD BOATS		USD 75
5608	LEFT BELL for OTHER BOATS		USD 75
5650	HOSE KIT		USD 50
5700	NITROGEN BOTTLE AND VALVE REPLACEMENT		USD 200
5750	BOTTLE SUPPORT		USD 50
5805	FLOATING BALLOON HOUSING KIT ASSEMBLY FOR BURGESS SAFETY CELL		USD 120
5806	FLOATING BALLOON HOUSING KIT ASSEMBLY FOR MOLGAARD SAFETY CELL		USD 120
5850	FLOATING BALLOON COVER for DAC RACING BOATS 1994 to 1998		USD 50
5851	FLOATING BALLOON COVER for DAC RACING BOATS 1999 to ----		USD 50
5855	FLOATING BALLOON COVER for BURGESS BOATS		USD 50
5856	FLOATING BALLOON COVER for MOLGAARD BOATS		USD 50
5900	PLASTIC RIVETS		USD 5

# ORDER SHEET

---

## S . B . S Y S T E M

### RETARTED FLOATING SYSTEM

If you are interested to purchase the S.B. System (Retarded Floating System), please return the following details to our address:

*Si vous etes intéressé par l'achat du S.B. System (Système Automatique de Flottement Retardé) veuillez nous retourner les détails suivant à notre adresse:*

Qualora foste interessati all'acquisto del S.B. System (Sistema Automatico di Galleggiamento) vi preghiamo di rinviarci iseguenti dati al nostro indirizzo:

**KARDALE Ltd.**  
**Secretarial Office**  
**"Le Saint André"**  
**20 Bld. De Suisse**  
**MC 98000 Monaco**  
**Fax +377 93 25 48 13**

Name / *Nom* / Nome : .....

Company / *Société* / Società : .....

Address / *Adresse* / Indirizzo : .....

Country / *Pays* / Paese : .....

VAT N° / *TVA N°* / P.IVA : .....

N° Kit (s) and P/N : .....

Spare Parts / *Pièce de rechange* : .....  
Parte di Ricambio

Hull / *Bateaux* / Scafo : .....

The invoice will be issued with or without VAT following your details. The S.B System will be delivered after reception of payment.

*La facture sera émise avec ou sans TVA selon vos coordonnées. Le S.B. System vous sera livré après réception du paiement.*

La fattura sarà emessa con o senza IVA in base ai vostri dati. L'S.B. System vi sarà inviato a ricezione del pagamento.

FOR ANY TECHNICAL DETAIL PLEASE CONTACT US:

---

## **S.B. SYSTEM**

### **DEVELOPMENT GROUP**

Via 4 Novembre, 69

22066 Mariano Comense - Como- Italy

Te +39 031 751015

Fax +39 031 751010

Email: [sb.system@tin.it](mailto:sb.system@tin.it)